

VAF

INSTRUMENTS



PT2 LoFlow[®] / MidFlow[®]

Sliding Vane Meters DN 15-50 (1/2" - 2")

I35

Product Bulletin

WWW.VAF.NL

TO BE
REALLY
SURE

Introduction

VAF Instruments PT2 Flowmeters are used in continuous metering applications. The positive displacement sliding vane type liquid Flowmeters have a simple, rugged design. With only few almost frictionless moving internal parts there is hardly any wear in the Flowmeter which safeguards a typical long lasting lifetime. PT2 meters have no mechanical seals saving you from regular maintenance and possible leakage of process liquids into the environment. The Flowmeter is driven by the process liquid which makes it suitable for distant locations without power supply. The high accuracy of the Flowmeter (better than 0,2% and repeatability 0,05%) is not influenced by process pressure or temperature, mechanical pipe strain or liquid turbulence and therefore straight inlet and outlet pipe pieces are not required.

Experience in flow measurement

In 1938 VAF Instruments started as a manufacturer of petrol delivery pumps. The Flowmeters made by VAF Instruments for this pump already had to have the highest accuracy and had to meet the demands of the board of weights and measures. Innovation and research over the past decades helped VAF Instruments to make new types of Flowmeters bearing in mind customer requirements and the need for accurate flow measurement. VAF Instruments Flowmeters are available in sizes from 8 mm up to 300 mm (1 l/hr up to 960 m³/hr).

Available PT Flowmeters

PT2 Flowmeters are available in connection sizes from 15 mm up to 50 mm representing maximum flow ranges from 50 l/min up to 500 l/min. The VAF PT2 Flowmeters are designed especially for fuel consumption measurement under difficult circumstances e.g. on board of ships.

Reversed flow direction

For applications where the flow direction can also be in reverse a special version of the pulse transmitter has been developed; the PTtwin. To detect the flow direction, the PTtwin has two pulse transmitters installed in the cover instead of one. The phase shift between both signals indicates the flow direction. In case the return flow or backflow is unwanted a special connection box can be supplied, together with the Flowmeter. The box has an integrated pulse discriminator, which ensures that the system will only provide pulse signals when the flow is in the correct direction.

Liquids

Other available models of VAF Instruments positive displacement Flowmeters are suitable for a wide range of liquids. Because liquids with higher viscosities do not degrade the accuracy of the sliding vane Flowmeter, it is possible to use only one Flowmeter for various liquids. PT2 Flowmeters are specially developed for measurement of all kinds of hydrocarbon liquids in particular medium and heavy fuel oils for combustion engines, lubricating oils and many other oil-like liquids. VAF PT2 Flowmeters can be delivered with various combinations of counters/flow computers. Refer to Application Bulletin AB-124 for Fuel Consumption Measurement. Consult our factory for the selection of the suitable model.

Principle of operation

VAF Instruments positive displacement Flowmeters operate on the sliding vane principle. The meter consists of a specially shaped housing in which a rotor can rotate freely. Two pairs of vanes are placed into four slots in the rotor. Each pair is positioned by a rod and can move in and out of the rotor. The radial movement of the vanes is guided by the special inner shape of the housing. This patented construction provides a constant seal between the inlet and the outlet of the meter. The incoming liquid forces the rotor to rotate. For protection of the Flowmeter appropriate liquid filtering is essential.

The rotation of the rotor is transferred via one or two (PTtwin) pulse transmitters mounted in the cover, which can be used for remote read out, flow data processing or connection to a process computer.

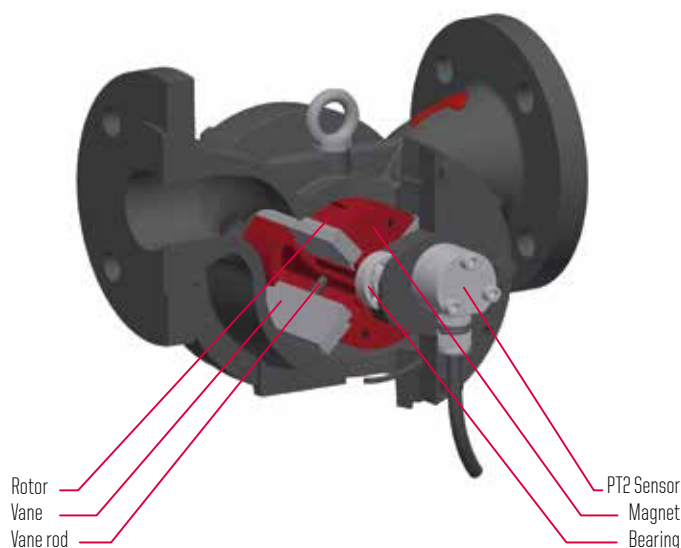

Section view of a PT2 Flowmeter

Applications of flow measurement

Flow measurement is used for a wide range of applications. Fuel consumption measurement can be performed in engine-driven installations in all kinds of power and propulsion plants. Various types of fuel can be measured, such as heavy fuel oil, diesel oil or bio-oil.

Depending on the type of fuel system it is necessary to have one, two or three Flowmeters installed. When the PT2 Flowmeter is combined with other sensors the system can be used for a variety of applications. For example a PT2 Flowmeter together with ViscoSense®3D provides a highly accurate and cost effective solution to measure mass flow for fuel consumption applications. And when it is combined with a monitoring or management system like FCM2, PEM4 or IVY®, the PT2 Flowmeters provide a vast range of applications.

Some of the many applications of VAF Instruments PT2 Flowmeters include:

- Fuel consumption measurement of diesel engines and oil burners;
- Engine performance (SFOC) when combined with power meter.
- Measurement of liquid movement in hydraulic systems;
- Accurate measurement of viscous liquids at low flowrates.
- Mass flow measurement
- MRV & IMO DCS reporting

Features and benefits

The advanced design of VAF Instruments PT2 Flowmeters includes many unique features and benefits offering a state of the art Flowmeter with the highest quality, capacity and accuracy.

Features

High capacity and rangeability

High accuracy (down to $\pm 0,2\%$)

Design simplicity

Accuracy not degraded by process conditions

Compact design

Few internal parts

Benefits

One meter for a wide range of flows combined with superior accuracy

Exact registration of transferred amount of liquid

Easy to service, due to no complex replacement parts

Low operating cost

One single meter model is suitable for different liquids against excellent performance

Easy to integrate in compact systems

Less wear - long lifetime - low operating cost



Monitoring and management solutions

The PT2 Flowmeters can be combined with the FCM2 flow computer, PEM4 Propulsion Efficiency Monitor, the vessel's monitoring system and/or IVY® propulsion performance management solution to use the Flowmeters to their full potential.



FCM2 Flow computer

For basic visualisation of the measured data in combination with a single Flowmeter or in a supply/return system, the PT2 Flowmeters can be combined with the FCM2 flow computer. This computer includes temperature compensation calculation. Furthermore it can be connected to the ViscoSense®3D for mass flow measurements.

PEM4 Propulsion Efficiency Monitor

The PEM4 is developed to monitor Fuel Consumption data. On its large touch screen display all important information is available at a glance. The intuitive navigation through the different screens offers not only real-time consumption data (compensated for temperature differences), but also other valuable information. The system can make automatic distinction between different fuel types and is able to monitor up to 12 Flowmeters (8 separate consumers) and can additionally be connected to a power meter, speedlog or GPS to obtain the specific fuel consumption per nautical mile or kWh. Connecting the PEM4 with the innovative ViscoSense®3D provides mass flow monitoring.



IVY® Propulsion Performance Management Solution

IVY®, VAF Instruments' solution for Propulsion Performance Management, brings you the fleet at your fingertips. From ship to shore, IVY® enriches big data for powerful analysis. The web application of IVY® provides fleet and ship performance visualisation and insight into the relevant data and more than 30 KPIs. IVY® can be combined with a range of sensors on board, including PT2 Flowmeters. IVY® brings Big Data back to the essence.

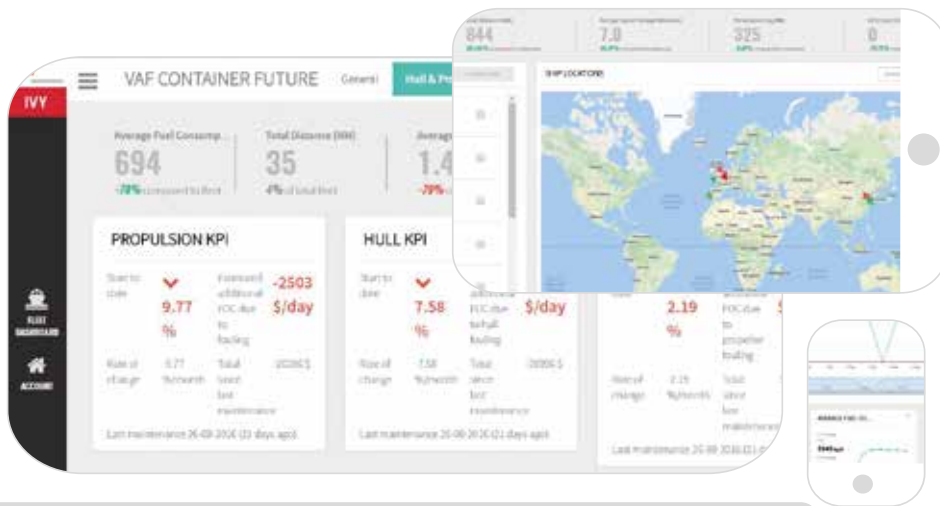

Dimensions

Built-in dimensions of Flowmeters with other pressure ratings are available on application.

All dimensions are in millimeters. Other dimensions depend on flange type, see technical manual TIB-144 for detailed information.

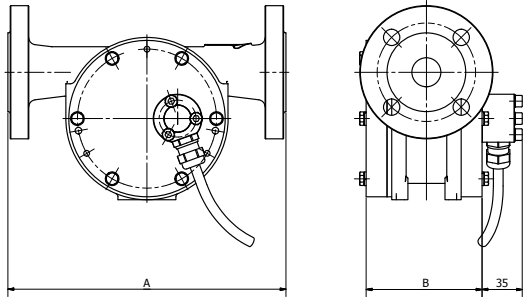

Dimensions

Basis model number	Connection size	A	B
J5015PT2	DN15	180	72
J5023PT2	DN25	220	72
J5025PT2	DN25	240	100
J5040PT2	DN40	240	100
J5050PT2	DN50	260	137

Technical specification

Basic model number	J5015PT2	J5023PT2	J5025PT2	J5040PT2	J5050PT2
Connection size [mm]	DN 15	DN 25	DN 25	DN 40	DN 50
Capacity	see graphs				
Maximum, 8 hrs/day discontinuous [l/min]	50		160	250	500
Maximum, continuous [l/min]	37,5		120	190	380
Displaced volume per revolution [liters]	0,025		0,167		0,40
Measuring accuracy					
Range 1:10 ³ better than	± 0,2%				
Repeatability better than	± 0,05%				
Required starting pressure [kPa (bar)]	3 (0,03)				
Materials					
Body and flanges	ductile iron				
Rotor	ductile iron				
Vanes	carbon				
O-rings	Viton A				
Bearings	steel ball bearings				
Body pressure rating [kPa (bar)]	4000 (40)		2000 (20)		
Available flanges					
DIN [bar]	PN 10, 16, 25				
ANSI	150, 300				
JIS [K]	5, 10, 16, 20				
Liquid temperature range	-10 to 150°C				
Type of pulse transmitter	Hall switch with active output				
Nominal output pulse transmitter	80 p/l		12/24 p/l		5/10 p/l
PT100 output	class B				
Weight [kg]	6	7	13	16	24

Notes:

1) Standard factory calibration 10% to 100% of maximum capacity

2) Calibration on application

Technical specification

Flowrate - pressure drop viscosity relation

To select the appropriate meter size for your process the graphs on this page must be used. The data in these graphs only refer to standard Flowmeters used on Newtonian liquids. Consult VAF Instruments for viscosities over 3000 mPa.s. Lower minimum capacities are possible depending on liquid viscosity and required measuring accuracy.

These graphs show the pressure drop across the Flowmeter as a function of the flowrate and the viscosity of the liquid. The sloping lines are lines of equal viscosity. The curve at the top of the graphs represents the maximum allowable pressure drop.

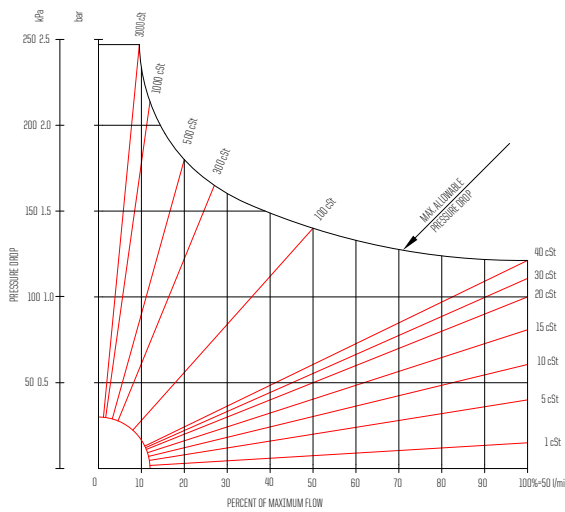

J5015PT2, J5023PT2: 100% = 50 l/min

Not recommend for use in HFO installations.

For applications involving HFO we advise our DN25 size Flowmeters

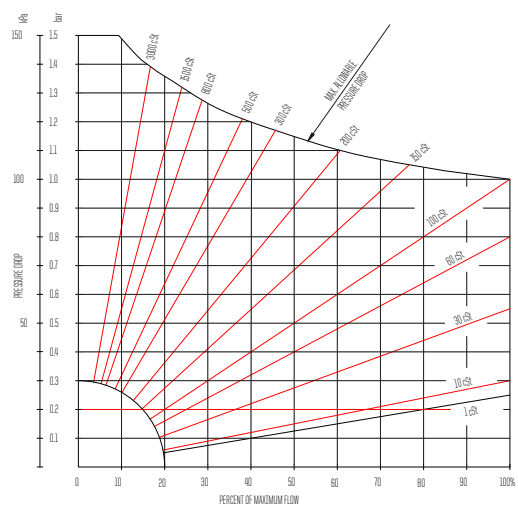

J5025PT2: 100% = 160 l/min

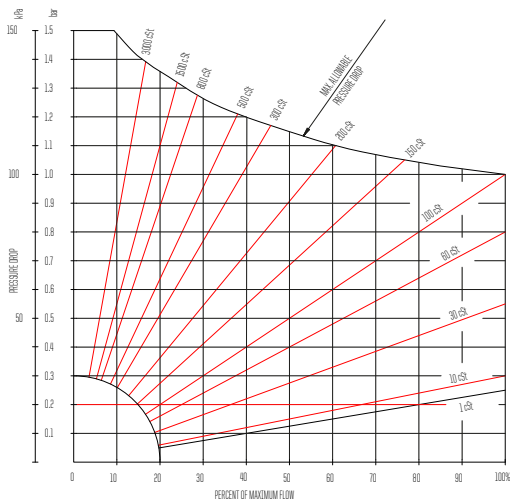

J5040PT2: 100% = 250 l/min

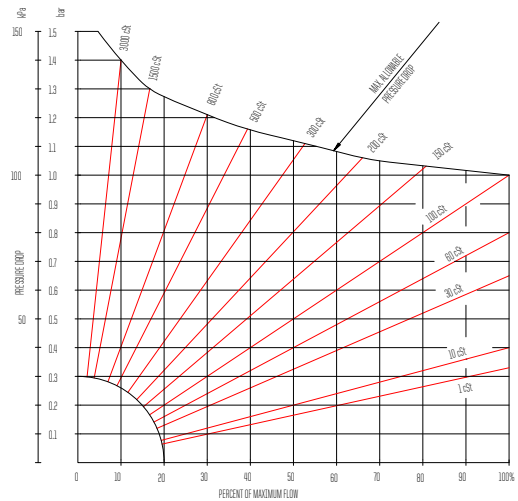

J5050PT2: 100% = 500 l/min

Quotation and ordering information

For proper selection of the suitable PT2 Flowmeter the following data should be determined:

Liquid data:

1.	Process liquid (trade name or chemical composition):		
2.	Flowrate minimum [l/min]:	Continuous [l/min]:	Maximum [l/min]:
3.	Operating pressure range [bar]:	allowable pressure drop [bar]:	
4.	Operating temperature range [°C] process liquid:	ambient:	
5.	Viscosity at operating conditions [cSt]:		

Flowmeter data:

6.	Basic model number:			
7.	Diameter liquid piping:			
8.	Connection flanges:	<input type="radio"/> DIN PN [bar]	<input type="radio"/> ANSI RF [lbs]	<input type="radio"/> JIS [K]
9.	Direction to flow:	left to right		
10.	Output	<input type="radio"/> pulse output + PT100 (standard) <input type="radio"/> twin pulse + PT100 <input type="radio"/> twin pulse incl. discriminator + PT100		
11.	Liquid filter:	<input type="radio"/> required	<input type="radio"/> not required	
12.	Certification:	<input type="radio"/> inspection by customer <input type="radio"/> inspection by classification authority: <input type="radio"/> factory test and material certificate acc. EN 10204 3.1 <input type="radio"/> other:		
13.	Tagging:	<input type="radio"/> paper tag	<input type="radio"/> stn. stl. tag fixed to Flowmeter	
14.	Monitoring-/ management solutions and accessories:	<input type="radio"/> FCM2 flow computer <input type="radio"/> PEM4 Propulsion Efficiency Monitor <input type="radio"/> IVV® Propulsion Performance Management		

Name:

Place and date:

Please fill out this form and send it to sales@vaf.nl. We will reply with a quotation and ordering information for the requested product or solution a.s.a.p.

For further information see relevant Product Bulletins or www.vaf.nl



All copyrights reserved | PB-135-GB-0519 | Superseides PB-135-GB-0418

VAF

INSTRUMENTS

VAF Instruments B.V.
Vierlinghstraat 24, 3316 EL Dordrecht, The Netherlands
P.O. Box 40, 3300 AA Dordrecht, The Netherlands
T +31 78 618 3100 | info@vaf.nl | www.vaf.nl

Specifications subject to change without notice
VAF Instruments B.V. is an ISO 9001 Certified Company
Agents and distributors in more than 50 countries